



## CARACTERÍSTICAS

- Hélices aerodinámicas y eficientes.
- Embocadura embutida en todos los tamaños con venturi prolongado para reducción de turbulencias.
- Diseño especial de soporte y base motor de gran resistencia, que facilita el mantenimiento.
- Rodamientos a bolas de uso industrial.
- Acabado de pintura en polvo poliéster electrostática, con protección anticorrosiva.
- Eje en acero calculado con diámetros que superan los parámetros de carga.
- Motores trifásicos totalmente cerrados, con ventilación forzada.

### Aplicaciones especiales (bajo pedido):

- Atmósferas corrosivas: acabado pintura epóxica y sistema epóxico poliéster.
- Extracción o ventilación de uso industrial.
- Ideal para mover grandes volúmenes de aire.
- Para ambientes donde el nivel sonoro sea un factor importante.

## CARACTERÍSTICAS TÉCNICAS

Dimensiones en mm

	HGB-T 800	HGB-T 1000	HGB-T 1250	HGT 1500	HGT 1800
<b>A</b>	1008	1174	1455	1769	2032
<b>B</b>	835	973	1255	1582	1724
<b>C</b>	800	1013	1261	1504	1850
<b>D</b>	468	548	555	694	900
<b>E</b>	90	98	103	170	19
<b>ØF</b>	15.9	15.9	15.9	15.9	22.2

# HGB-T Extractores helicoidales

## HGB-T 800, 1000, 1250, 1500 y 1800

Este modelo es el resultado de procesos productivos de tecnología y control de calidad avanzado.

Álabes de características especiales y diseño eficiente con 22 configuraciones de hélice de motor.

## RANGOS DE FABRICACIÓN

### Modelos 800 (31") a 1250 (49")

Hélices de 6 álabes con diseño aerodinámico fabricado en acero al carbón y unido a un disco estrella, embutido de fijación a flecha.

### Modelos 1500 (59") y 1800 (71")

Hélices de gran robustez, con 6 álabes para el modelo 1800 y 5 palas para el modelo 1500. Fabricadas en acero al carbón, unidas al casquillo por un cartabón en placa de acero de gran resistencia y asegurada con tornillería especial.

## APLICACIONES



ALMACENES Y BODEGAS



NAVES INDUSTRIALES



INVERNADEROS



LOCALES DEPORTIVOS

## ACCESORIOS

Consultar pág. 145

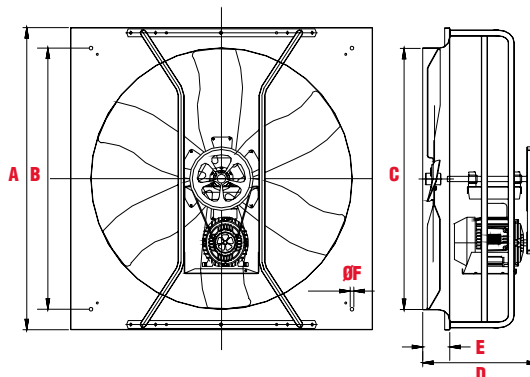
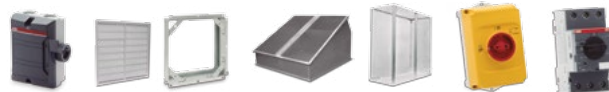



## CARACTERÍSTICAS TÉCNICAS

\*Los valores de velocidad, potencia, voltaje e intensidad son nominales

\*Nivel sonoro medido de acuerdo con las normas AMCA 300/05 y 301/05

Modelo	Velocidad RPM	Potencia HP	Tensión Volts	Intensidad A	Caudal a descarga libre m³/hr / CFM	Presión sonora dB (A)*	Peso aprox. kg
HGB-800- 1/2	530	1/2	127 / 220	10.8 / 4.6	12,146 / 7,145	58	41
HGT-800- 1/2	530	1/2	208 -230 / 460	1.99-1.9 / 0.98	12,146 / 7,145	58	41
HGT-800- 3/4	700	3/4	208 -230 / 460	2.8-3.2 / 1.6	16,200 / 9,529	66	41
HGB-800- 1	800	1	127 / 220	14.2 / 6.83	18,340 / 10,788	69	41
HGT-800- 1	800	1	230 / 460	3.0 / 1.5	18,340 / 10,788	69	41
HGT-1000- 3/4	550	3/4	208-230 / 460	4.3 / 2.1	24,666 / 14,509	67	48
HGB-1000- 1	610	1	127 / 220	29.0 / 13.5	27,630 / 16,253	69	48
HGT-1000- 1	610	1	230 / 460	5.7 / 2.8	27,630 / 16,253	69	48
HGT-1000- 1 1/2	700	1 1/2	230 / 460	4.3 / 2.1	31,663 / 18,625	72	48
HGB-1250- 1	450	1	127 / 220	14.2 / 6.83	32,300 / 19,000	68	61
HGT-1250- 1	450	1	230 / 460	3.0 / 1.5	32,300 / 19,000	68	61
HGT-1250- 1 1/2	500	1 1/2	230 / 460	4.3 / 2.1	35,833 / 21,078	70	61
HGB-1250- 2	540	2	127 / 220	29.0 / 13.5	38,900 / 22,882	72	65
HGT-1250- 2	540	2	230 / 460	5.7 / 2.8	38,900 / 22,882	72	65
HGT-1250- 3	610	3	230 / 460	7.8 / 3.9	43,750 / 25,735	74	76
HGT-1500- 3	550	3	230 / 460	7.8 / 3.9	59,400 / 34,941	76	144
HGT-1500- 5	550	5	230 / 460	12.5 / 6.2	74,630 / 43,900	79	148
HGT-1500- 7 1/2	550	7 1/2	230 / 460	18.1 / 9.1	85,989 / 50,581	84	164
HGT-1500- 10	550	10	230 / 460	23.9 / 11.9	92,582 / 54,460	87	172
HGT-1800- 7 1/2	440	7 1/2	230 / 460	18.1 / 9.1	104,445 / 61,438	81	311
HGT-1800- 10	440	10	230 / 460	23.9 / 11.9	118,340 / 69,612	85	318
HGT-1800- 15	440	15	208-230 / 460	35.8 / 17.9	136,875 / 80,515	89	358

## CARACTERÍSTICAS ACÚSTICAS

Espectro de potencia sonora en dB(A) por banda de frecuencia en HZ.

MODELO	63	125	250	500	1000	2000	4000	8000	LwA	dB(A)
HGB-T 800 - 1/2	58	61	68	66	65	62	56	52	69	58
HGT 800 - 3/4	66	69	76	74	73	70	64	60	77	66
HGB-T 800 - 1	70	73	80	77	76	73	67	63	81	69
HGT 1000 - 3/4	66	70	77	75	74	71	65	61	78	67
HGB-T 1000 - 1	68	72	79	77	76	73	67	62	80	69
HGT 1000 - 1 1/2	71	75	82	80	79	76	70	66	83	72
HGB-T 1250 - 1	67	71	78	76	75	72	66	63	79	68
HGT 1250 - 1 1/2	69	73	80	78	77	74	68	65	81	70
HGB-T 1250 - 2	71	75	82	80	79	76	70	67	83	72
HGT 1250 - 3	73	77	84	82	81	78	72	69	85	74
HGT 1500 - 3	75	79	86	84	83	80	74	71	87	76
HGT 1500 - 5	78	82	89	87	86	83	77	74	90	79
HGT 1500 - 7 1/2	83	87	94	92	91	88	82	79	95	84
HGT 1500 - 10	85	90	97	96	94	91	85	82	99	87
HGT 1800 - 7 1/2	79	84	91	90	88	85	79	76	93	81
HGT 1800 - 10	84	89	95	94	92	89	83	80	97	85
HGT 1800 - 15	86	91	97	96	94	91	85	82	100	89

## CURVAS CARACTERÍSTICAS

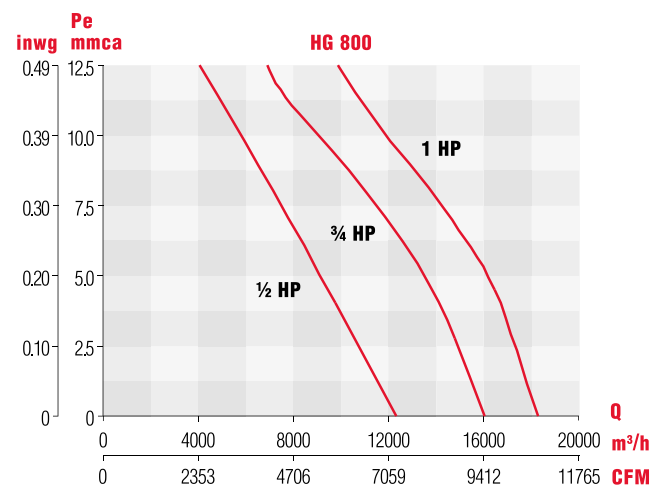



**CARACTERÍSTICAS ACÚSTICAS**

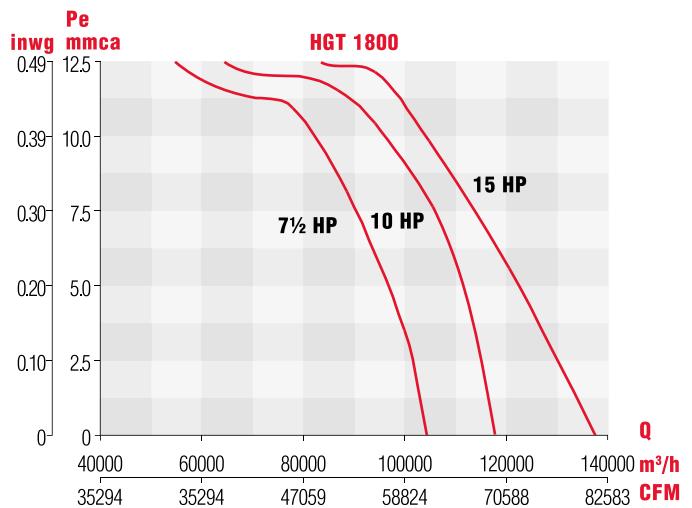
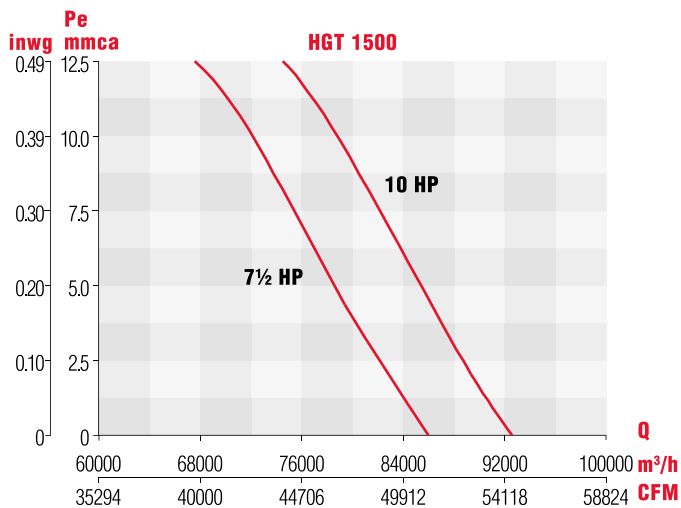
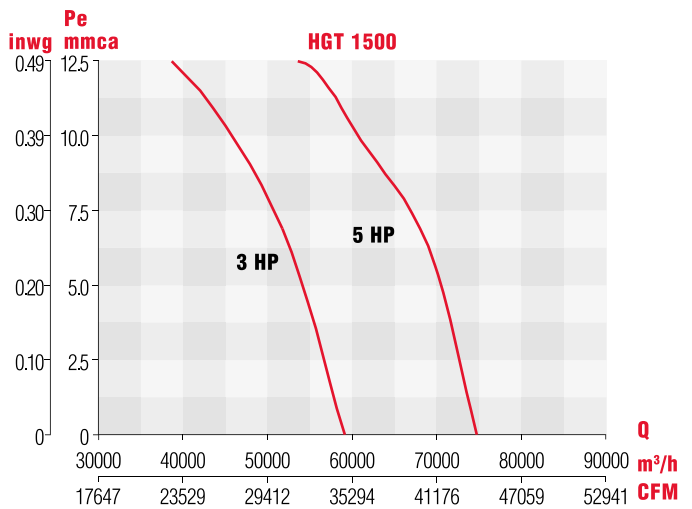
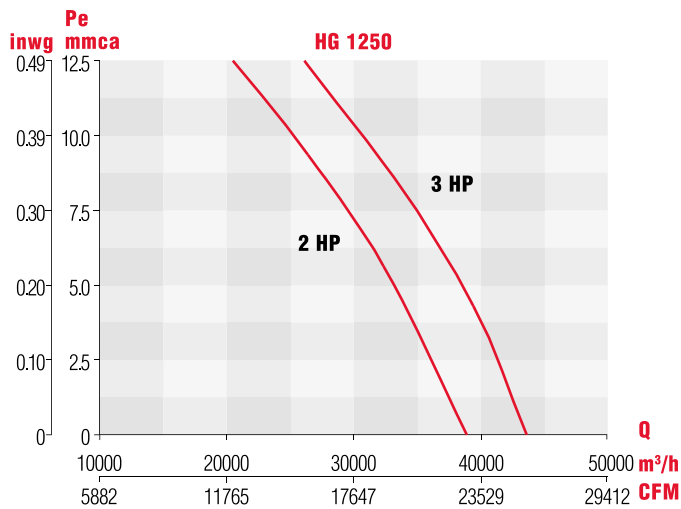
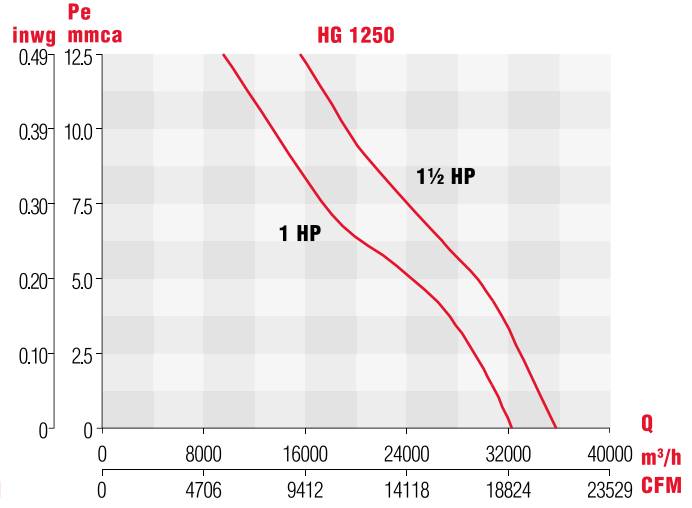
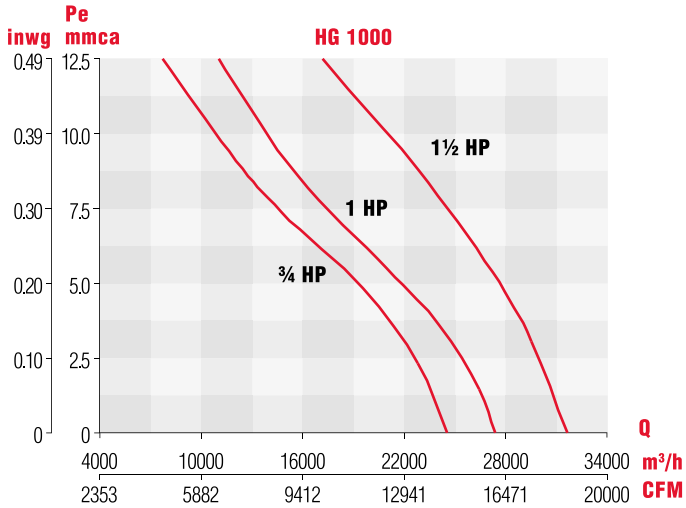



Ventiladores axiales con transmisión  
HGB-T

